



# JUICE AND AYRAN MAKER

## CONTENTS

---

<b>A</b>	<b>GENERAL INFORMATION .....</b>	<b>Page 2</b>
A1	PRODUCT DESCRIPTION .....	Page 3
A2	TECHNICAL INFORMATION.....	Page 3
A3	TRANSPORTATION .....	Page 4
A4	UNPACKING .....	Page 4
<b>B</b>	<b>INSTALLATION .....</b>	<b>Page 4</b>
<b>C</b>	<b>SAFETY INSTRUCTIONS.....</b>	<b>Page 5</b>
<b>D</b>	<b>OPERATION .....</b>	<b>Page 6</b>
<b>E</b>	<b>CLEANING &amp; MAINTENANCE.....</b>	<b>Page 7</b>
<b>F</b>	<b>TROUBLESHOOTING .....</b>	<b>Page 8</b>
<b>G</b>	<b>SPARE PART LIST- EXPLODING DRAWING .....</b>	<b>Page 9</b>

## A GENERAL INFORMATION

---

Before installing the appliance, read operation and maintenance instructions carefully. Wrong installation and part changing may damage the product or may cause injury on people. These are not in our company's responsibility to damage the appliance intentionally, negligence, detriments because of disobeying instructions and regulations, wrong connections. Unauthorized intervention to appliance invalidates the warranty.

1. This instruction manual should be kept in a safe place for future reference.
2. **Installation should be made in accordance with ordinances and security rules of that country by a qualified service personnel.**
3. This appliance has to be used by trained person.
4. Please turn off the appliance immediately in the event of malfunction or failure. The appliance should be repaired only by authorized service personnel. Please demand original spare part.

# JUICE AND AYRAN MAKER

## A1 PRODUCT DESCRIPTION

---

\*The Professional Juice and ayran Maker, that provides high efficiency has been designed to be used in industrial kitchens.

Product Code	Dimensions (mm)	Weight (kg)	Packaging Dimensions (mm)
EMP.SY.19	320x400x700	20	330x410x710

## A2 TECHNICAL INFORMATION

---

Product Code	Capacity (Lt)	Coolant gas	Operat. Voltage (V)	Cable (mm <sup>2</sup> )	Fuse (A)
EMP.SY.19	19	R134A	230 -50 HZ	3x1,5	10

\*Volume level: 70 dB

**A3 TRANSPORTATION**

---

\*This appliance can not be moved by hand from area to area. It must be moved on pallet with forklift truck.

**A4 UNPACKING**

---

\*Please unpack the package according to the security codes and ordinances of current country and get rid from the pack. Parts which contacts with food are produced by stainless steel. All plastic parts are marked by material's symbol.

\*Please check that all the parts of appliance had come completely and if they are damaged or not during the shipping.

**B INSTALLATION**

---

\*Please place the product to straight and sturdy ground, please take necessary steps against possibility of overturn.

\*Technician who will serve for installation and service for the appliance must be professional on this subject and must have installation and service licenses by the company.

\*Connection to Electric Power Supply must be done by authorized person.

\*Please be sure that the voltage connected to appliance must be equal with the voltage which is on appliance's label.



This appliance must be connected to an earthed outlet in accordance with safety rules and standards.









\*Appliance's earthing must be connected to earthing line on panel which is nearest to electric installation.

\*Connection to the main fuse and leak current fuse must be done in accordance with the current regulations.

## JUICE AND AYRAN MAKER

### C SAFETY INSTRUCTIONS

---

-  \*Do not use the appliance in insufficient lighted place.
-  \*Do not touch the moving attachments while the appliance operates.
-  \*Do not install the appliance in the presence of flammable or explosive materials.
-  \*Do not operate the appliance when the machine is empty.
-  \*Do not load so less or more than appliance's capacity .
-  \*Do not attempt to use the appliance without suitable protective equipments.
-  \*Because of any reason if there is a fire or flame flare where the appliance is used,turn off all gas valves and electric contactor switch quickly and use fire extinguisher .Never use water to extinguish the fire.
-  \*All the damages because of not having earthing connection will not be on warranty.
-  \*Do not leave juice or ayran in the tank from previous day.

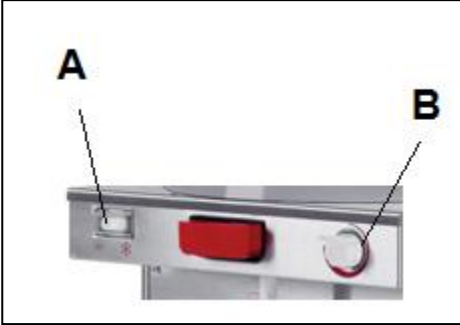
**D OPERATION****\* Control Panel::****A : ON-OFF BUTTON****B : THERMOSTAT BUTTON****Operating;**

- Wash the ayran or juice tank before using the appliance.Clean and dry.
- Plug in the appliance and switch to ON position.
- Pour the ayran or juice that is prepared into the tank.
- Set the desired temperature by using heat setting button.
- In order to take off the ayran or juice that is served cold,place the cup to the lower filter and fill from the tap.
- After the operation completed,switch to OFF position and unplug the appliance

## JUICE AND AYRAN MAKER

### **E      CLEANING & MAINTENANCE**

---

#### ➤ **CLEANING AND MAINTENANCE AFTER EVERY USE**

- Always turn off the appliance and disconnect from the power supply before cleaning.
- Clean the ayran tank after every use.
- Pay attention the cleaning materials to be hygienic.
- Do not use abrasive cleaning chemicals as these can leave harmful residues.
- Do not clean the appliance by spraying water directly, otherwise electric motor may get damaged

#### ➤ **PERIODIC CLEANING AND MAINTENANCE**

- Maintenance should be done by qualified person.
- Get the periodic maintenance of the appliance once in every 15 days.
- Check the coolant gas in periodik times.

**F TROUBLESHOOTING****THE APPLIANCE DOESN'T OPERATE**

1. Check if the appliance is plugged in.
2. Check the electrical connections and voltage.
3. Check if the fuse is on or off.

**THE APPLIANCE IS NOISY**

1. Check the motor.

**THE APPLIANCE STOPPED**

1. The appliance can stop due to low voltage. In this situation check the voltage.
2. If there is leakage current, the appliance doesn't operate. Check it.

- If ayran or juice maker is not done at suitable quality
- If any function of security doesn't work
  - Do not use the appliance.

**\*If these problems are still going on, contact with our authorized services.**



# JUICE AND AYRAN MAKER

## G SPARE PART LIST-EXPLODING DRAWING

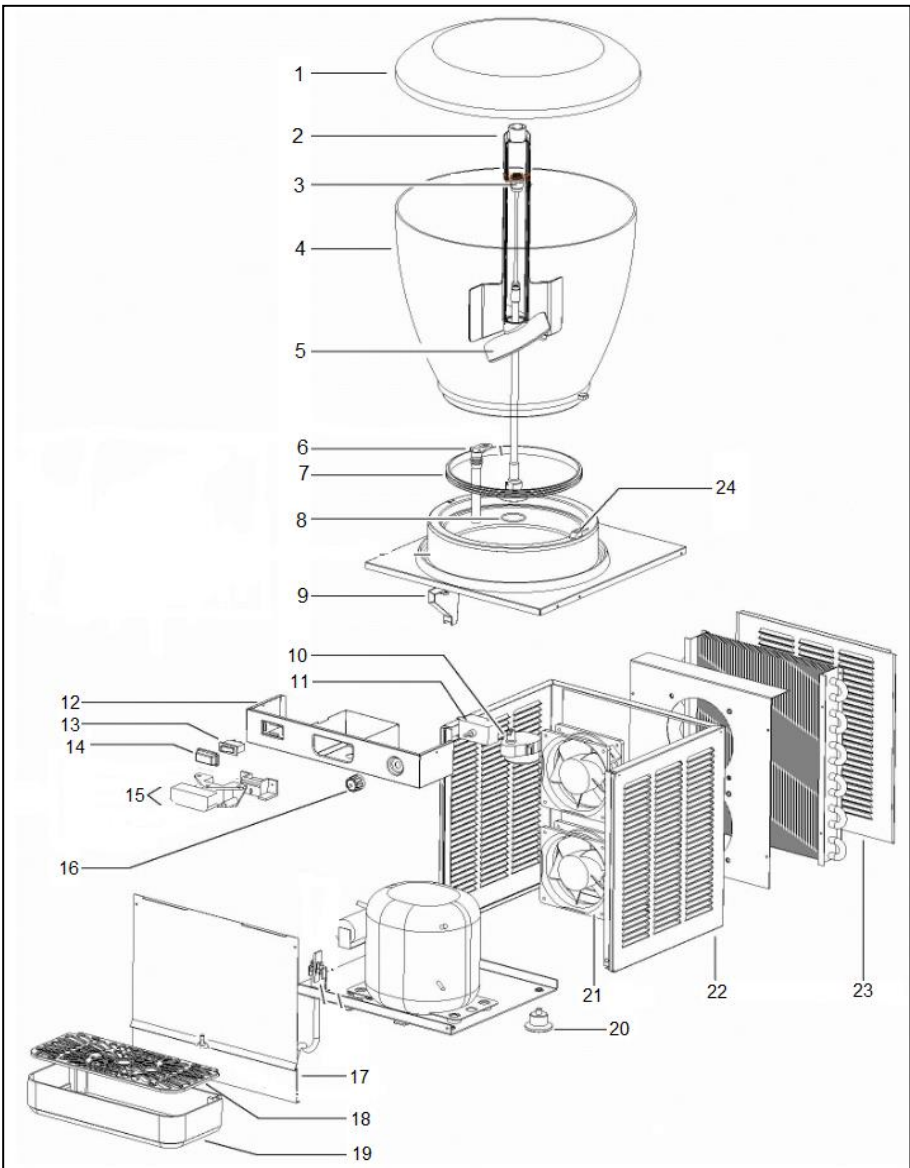

**G SPARE PART LIST-EXPLODING DRAWING**

<b>PRODUCT CODE: EMP.SY.19</b>		
<b>NO</b>	<b>PRODUCT NAME</b>	<b>P.CODE</b>
1	TANK LID	Y.EMP.SY.19.001
2	MIXER	Y.EMP.SY.19.002
3	ACTUATING SHAFT	Y.EMP.SY.19.003
4	TANK	Y.EMP.SY.19.004
5	MIXER	Y.EMP.SY.19.005
6	TAP (SILICONE)	Y.EMP.SY.19.006
7	SILICONE GASKET (TANK)	Y.EMP.SY.19.007
8	ORING	Y.EMP.SY.19.008
9	DRAINAGE PIPE	Y.EMP.SY.19.009
10	PROPULSION MOTOR	Y.EMP.SY.19.010
11	THERMOSTAT	Y.EMP.SY.19.011
12	CONTROL PANEL SHEETMETAL	Y.EMP.SY.19.012
13	START-STOP BUTTON	Y.EMP.SY.19.013
14	BUTTON GUARD (SILICONE)	Y.EMP.SY.19.014
15	TAP GROUP	Y.EMP.SY.19.015
16	THERMOSTAT ADJUSTMENT BUTTON	Y.EMP.SY.19.016
17	FRONT PANEL SHEETMETAL	Y.EMP.SY.19.017
18	DRIP TRAY A LID	Y.EMP.SY.19.018
19	DRIP TRAY	Y.EMP.SY.19.019
20	FEET	Y.EMP.SY.19.020
21	FAN MOTOR	Y.EMP.SY.19.021
22	OUTER BASE FRAME	Y.EMP.SY.19.022
23	BACK LID SHEETMETAL	Y.EMP.SY.19.023
24	TANK LOCK	Y.EMP.SY.19.024